

SENSOR PRODUCTS SELECTION MANUAL



Wenzhou Gtric Technology Co., Ltd.
TEL:0577-62734566
Web:<http://www.gtric.com>
Mail: yaohaofeng@gtric.com

Company introduction

Wenzhou Gtric Technology Co., Ltd. is located in Yueqing IoT sensors Park, which covers 5,000 square meters, with over 100 employees. We are focuses on intelligent manufacturing and industrial automation, our main businesses are sensors, encoders, button switch, coupling, expansion set and other industrial automation products, providing standard and individual products and solutions for customers.

Our products cover over 20 series, 1000specificatison, which have passed CCC, CE, UL, ISO9001 certification as well as EU RoHS Environmental Directives.

Based on our technical advantages, Gtric can provide industrial automation solution according to customers' requirements.

**We support OEM & ODM, if you need
please feel free to contact us**



Installation conditions

Non shielded proximity switches can achieve maximum operating distance (with the diameter of the relevant); but in order to prevent the switch around the metal impact on the switch, the sensor head must be in a certain gap with the surrounding metal (Figure 1).

Due to the special shielding effect inside the shield, the radial magnetic field of the side is reduced, and the induction distance is about 60% of the non shield type, because it can be flush mounted in the metal (Figure 2).

The magnetic sensor is not affected by the conditions of installation, as long as the material around the material is not magnetized.

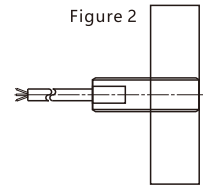
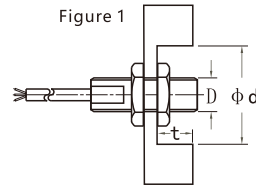

In order to prevent mutual interference, we must keep the minimum distance between each other (Figure 3).

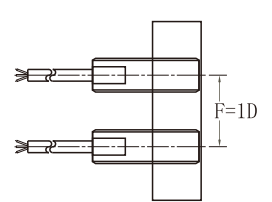
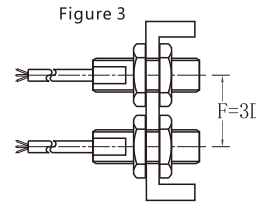

Please refer to the specific data of various types of instructions.

Output mode and electrical characteristics

DC 2-wire system NO or NC

The load must be connected in series in the sensor to work, there is a polarity and short circuit protection function; in the open circuit state, there is a very small leakage current; in the closed circuit, the switching element has a smaller voltage drop.

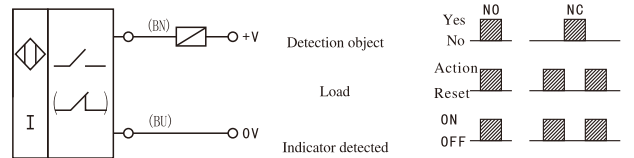

DC 3-wire system (N,P type) NO or NC

These switches are connected to the load and power supply separately; the polarity, short circuit and overload protection function, and the residual current can be ignored.

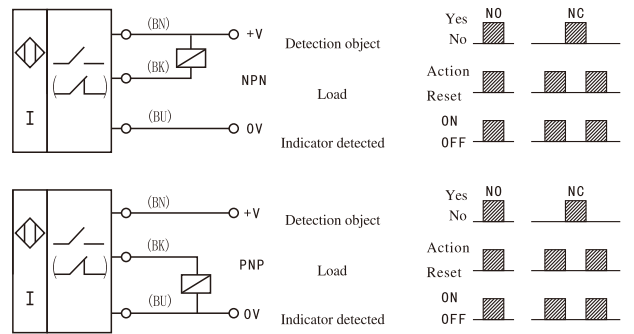

AC 2-wire system NO or NC

The load must be connected in series in the sensor, in the closed circuit, the switching element has a smaller voltage drop.

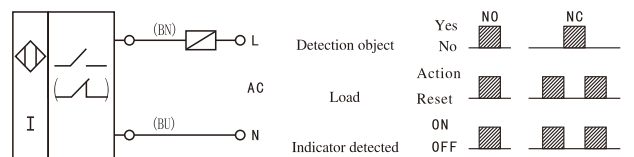

DC 4-wire system (NPN, PNP Type) NO+NC

Sensor switches can provide 2 groups of output NO+NC

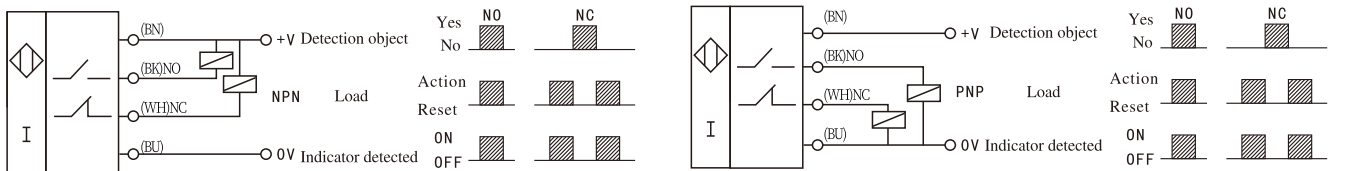

DC 4-wire system (NPN, PNP Type) NO/NC

The switches can provide two groups of output NO or NC

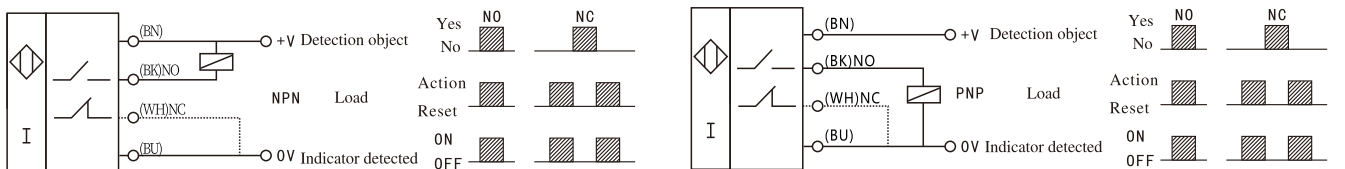

NO+NC Ac/Dc five wire (relay output) NO + NC

These switches can provide to often open, closed two group relay output.

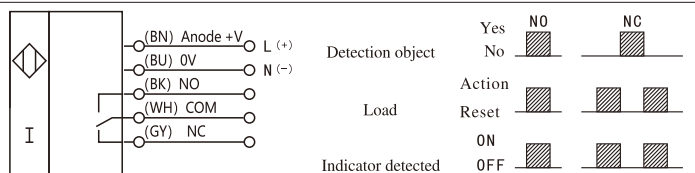

❖ Series and parallel connection of proximity switch

OR connection (NPN and PNP types can be used mixed) series When the proximity switch is OR connected, the action of any proximity switch can drive load. The quantity of the proximity switches depends on the sum of leakage current. More connections are available given that it doesn't affect the loading action.

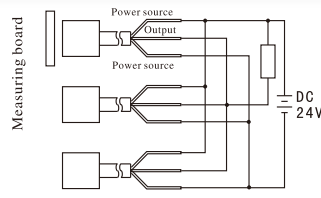

OR connection of NPN output

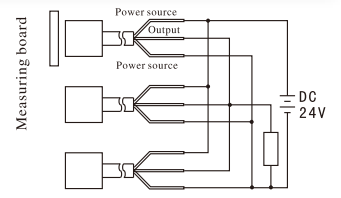

OR connection of PNP output

❖ AND connection (series)

When the proximity switch is AND connected, the action of all proximity switches can drive load. The quantity of the proximity switches depends on the sum of saturation voltage. More connections are available given that it doesn't affect the supply voltage of the proximity switch. The response frequency of the proximity switch is the accumulation of initialized reset of various proximity switch.

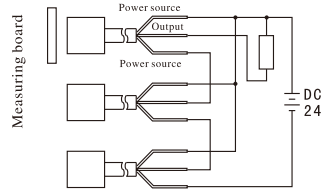

NPN connection of AND output

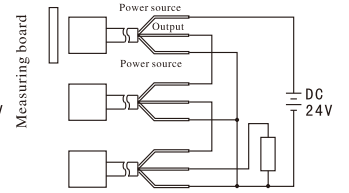

PNP connection of AND output

❖ Series and parallel connection of proximity switch

AND connection (series) NPN, PNP mixed-use

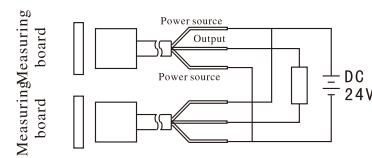

Promixity switches matters need attention

❖ Cautions when connected or disconnected with the power supply

When connecting the proximity switch with the counter and the programmable controller, there isn't any problem because of the built-in initialized reset circuit. Please avoid the conditions mentioned below.

The detection object lies around the detection distance of the proximity switch; For DC voltage type and DC switch type, when power supply is turned on (turned off), time constant rises (drops) greatly; There is self-excitation and noise when the AC switch type proximity switch is power-on (off).

❖ Capacitor, light load

The proximity switch can't have the capacitor or light that has larger jumping current as the load directly connected to be connected through a relay or series connected with a current-limiting resistance. The peak current set by current-limiting resistance R is within the load current of the proximity switch; Make sure to connect through load.

$$\frac{\text{Supply voltage } V}{\text{Peak load current value of proximity switch } mA} \leq R(K\Omega)$$

$$\text{Allowable loss of resistance } R (W) = \frac{\text{Supply voltage } V^2}{\leq R(K\Omega)} \times 2 \text{ times above}$$

❖ Installation notice of proximity switch

Don't use it in the open air, and use a protective cover, if necessary.

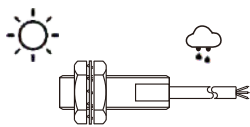

Don't knock the detection surface with hard objects and use a protective cover, if necessary.

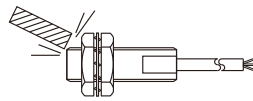

Don't use it in the environment with corrosive objects.

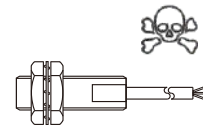

Don't fasten it with a big force, but fasten it with spring washer.

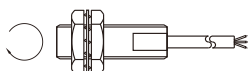

The proximity switch must be equipped individually with metal flexible pipe, and don't make it with the electric line and power line in the same metal flexible pipe.

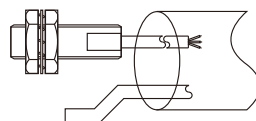

Don't stretch the power line of the proximity switch with a big force.

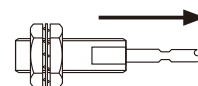

- ※ With overload short circuit, reverse connection protection, surge absorption
- ※ Can sense non-metallic objects



Selection Guide



C	R	12	04	N	1	□	□
①	②	③	④	⑤	⑥	⑦	⑧
① Model: L: Inductive、C: Capacitive、M: Reed Magnetic Switch、H: Hall switch、F: remote inductive							
② External structure: R: Cylindrical、F: Corner column type							
③ DIA. of sensing side: Number: DIA. of sensing side (unit:mm)							
④ Sensing distance: Number: Sensing distance (unit:mm)							
⑤ Power supply: N: NPN 10-30VDC 3-wire、P: PNP 10-30VDC 3-wire、D: 10-30VDC 2-wire A: 90-250VAC 2-wire							
⑥ Control output: 1: Normally open、2: Normally closed							
⑦ Connection: No mark: Cable type、P: Connector type、WP: Cable connector type							
⑧ Tail line length: No mark:2M Cable number: (unit m)							

Specifications



Specifications			
Model	DC3-wireNPN.NO	CR12-02N1	CR12-05N1
	DC3-wireNPN.NC	CR12-02N2	CR12-05N2
	DC3-wirePNP.NO	CR12-02P1	CR12-05P1
	DC3-wirePNP.NC	CR12-02P2	CR12-05P2
	AC2-wireNO	\	\
	AC2-wireNC	\	\
Mounting	Flush		Non-Flush
Sensing distance	2mm±20%		5mm±20%
Hysteresis	≤20%		≤20%
Detect objects	Conductors and Dielectrics		
Standardsensingtarget	Ground metal plate 50*50*1mm		
Supply voltage	DC:10-30VDC		
Response frequency(F)	500Hz (DC)		
Load current	200mA		
Voltagedrop	≤2.5V		
Circuitprotection	Short-circuit, overload, reverse polarity protection		
Outputindicator	Red LED		
Ambienttemperature	-20~+70°C		
Shock	500m/s(50G)ineachX,Y,Z directionfor 3 times		
Vibration	1mm amplitudeatfre quency 10~55Hz(for1min) ineachX.Y Zdirection for 2hours		
Protectiondegree	IP65		
Connection	2mPVCcable		
Meterial	Nickel-copperalloy		
Sensing side	PBT		

Dimension

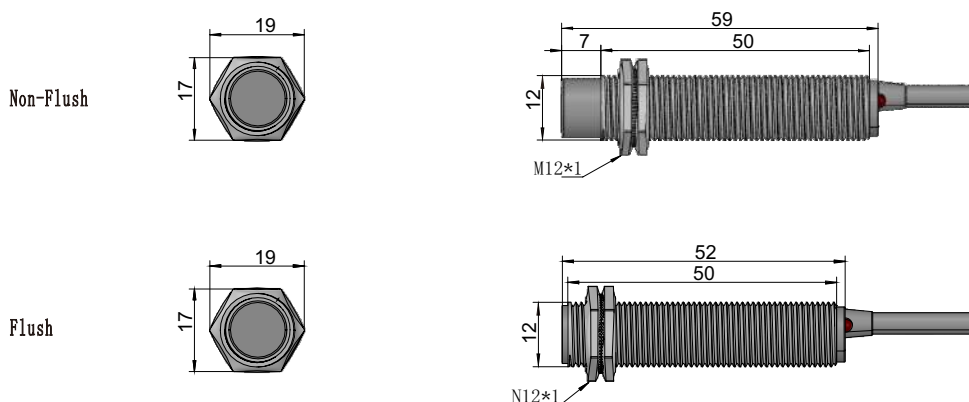



GTRIC[®]

Wenzhou Gtric Technology Co., Ltd.

Wenzhou Gtric Technology Co., Ltd.
TEL:0577-62734566
Web:<http://www.gtric.com>
Mail:yaohaofeng@gtric.com