

SENSOR PRODUCTS SELECTION MANUAL



Wenzhou Gtric Technology Co., Ltd.
TEL:0577-62734566
Web:<http://www.gtric.com>
Mail: yaohaofeng@gtric.com

Company introduction

Wenzhou Gtric Technology Co., Ltd. is located in Yueqing IoT sensors Park, which covers 5,000 square meters, with over 100 employees. We are focuses on intelligent manufacturing and industrial automation, our main businesses are sensors, encoders, button switch, coupling, expansion set and other industrial automation products, providing standard and individual products and solutions for customers.

Our products cover over 20 series, 1000specificatison, which have passed CCC, CE, UL, ISO9001 certification as well as EU RoHS Environmental Directives.

Based on our technical advantages, Gtric can provide industrial automation solution according to customers' requirements.

**We support OEM & ODM, if you need
please feel free to contact us**



Installation conditions

Non shielded proximity switches can achieve maximum operating distance (with the diameter of the relevant); but in order to prevent the switch around the metal impact on the switch, the sensor head must be in a certain gap with the surrounding metal (Figure 1).

Due to the special shielding effect inside the shield, the radial magnetic field of the side is reduced, and the induction distance is about 60% of the non shield type, because it can be flush mounted in the metal (Figure 2).

The magnetic sensor is not affected by the conditions of installation, as long as the material around the material is not magnetized.

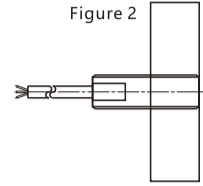
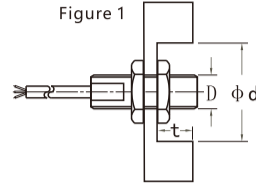

In order to prevent mutual interference, we must keep the minimum distance between each other (Figure 3).

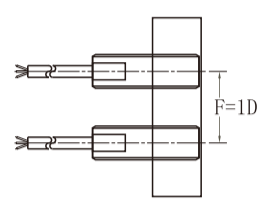
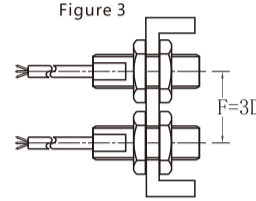

Please refer to the specific data of various types of instructions.

Output mode and electrical characteristics

DC 2-wire system NO or NC

The load must be connected in series in the sensor to work, there is a polarity and short circuit protection function; in the open circuit state, there is a very small leakage current; in the closed circuit, the switching element has a smaller voltage drop.

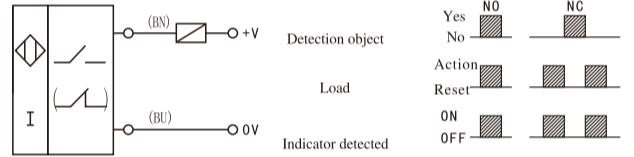

DC 3-wire system (N,P type) NO or NC

These switches are connected to the load and power supply separately; the polarity, short circuit and overload protection function, and the residual current can be ignored.

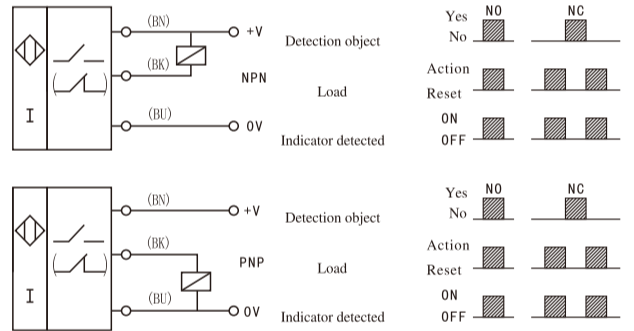

AC 2-wire system NO or NC

The load must be connected in series in the sensor, in the closed circuit, the switching element has a smaller voltage drop.

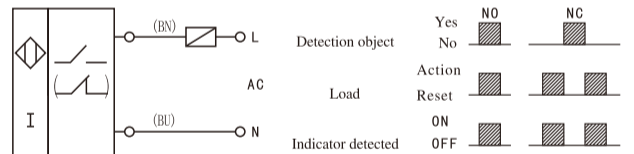

DC 4-wire system (NPN, PNP Type) NO+NC

Sensor switches can provide 2 groups of output NO+NC

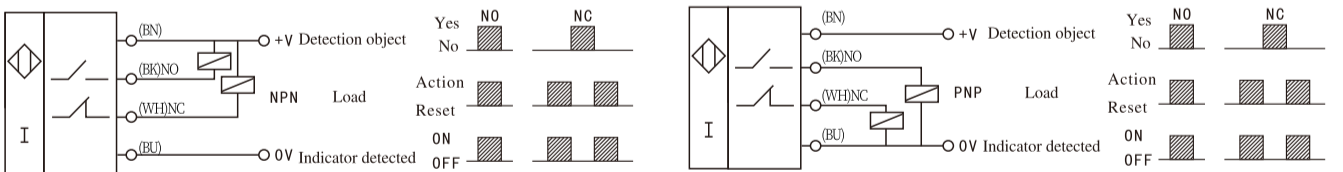

DC 4-wire system (NPN, PNP Type) NO/NC

The switches can provide two groups of output NO or NC

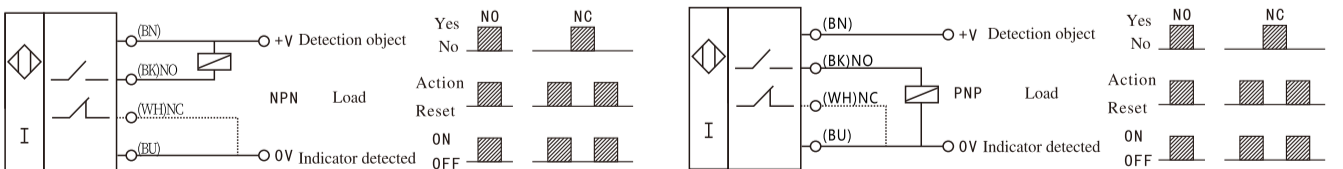

NO+NC Ac/Dc five wire (relay output) NO + NC

These switches can provide to often open, closed two group relay output.

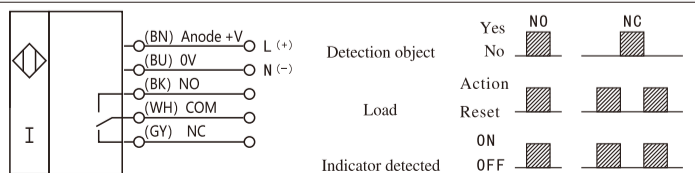

❖ Series and parallel connection of proximity switch

OR connection (NPN and PNP types can be used mixed) series When the proximity switch is OR connected, the action of any proximity switch can drive load. The quantity of the proximity switches depends on the sum of leakage current. More connections are available given that it doesn't affect the loading action.

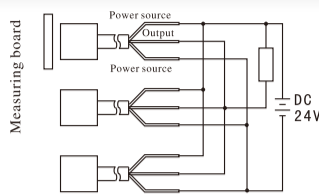

OR connection of NPN output

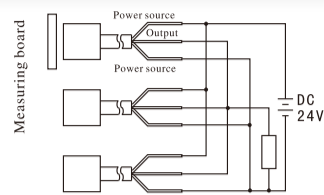

OR connection of PNP output

❖ AND connection (series)

When the proximity switch is AND connected, the action of all proximity switches can drive load. The quantity of the proximity switches depends on the sum of saturation voltage. More connections are available given that it doesn't affect the supply voltage of the proximity switch. The response frequency of the proximity switch is the accumulation of initialized reset of various proximity switch.

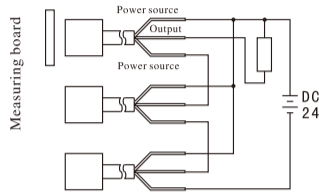

NPN connection of AND output

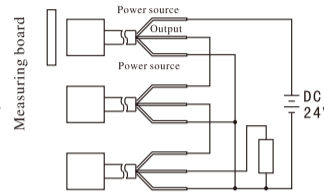

PNP connection of AND output

❖ Series and parallel connection of proximity switch

AND connection (series) NPN, PNP mixed-use

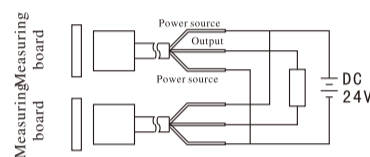

Promixity switches matters need attention

❖ Cautions when connected or disconnected with the power supply

When connecting the proximity switch with the counter and the programmable controller, there isn't any problem because of the built-in initialized reset circuit. Please avoid the conditions mentioned below.

The detection object lies around the detection distance of the proximity switch; For DC voltage type and DC switch type, when power supply is turned on (turned off), time constant rises (drops) greatly; There is self-excitation and noise when the AC switch type proximity switch is power-on (off).

❖ Capacitor, light load

The proximity switch can't have the capacitor or light that has larger jumping current as the load directly connected to be connected through a relay or series connected with a current-limiting resistance. The peak current set by current-limiting resistance R is within the load current of the proximity switch; Make sure to connect through load.

$$\frac{\text{Supply voltage } V}{\text{Peak load current value of proximity switch } mA} \leq R(K\Omega)$$

$$\text{Allowable loss of resistance } R (W) = \frac{\text{Supply voltage } V^2}{\leq R(K\Omega)} \times 2 \text{ times above}$$

❖ Installation notice of proximity switch

Don't use it in the open air, and use a protective cover, if necessary.

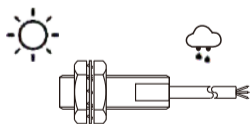

Don't knock the detection surface with hard objects and use a protective cover, if necessary.

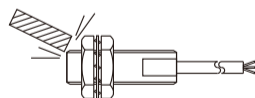

Don't use it in the environment with corrosive objects.

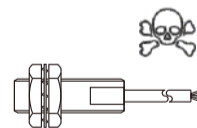

Don't fasten it with a big force, but fasten it with spring washer.

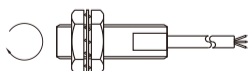

The proximity switch must be equipped individually with metal flexible pipe, and don't make it with the electric line and power line in the same metal flexible pipe.

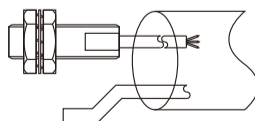

Don't stretch the power line of the proximity switch with a big force.

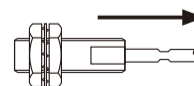

- ※ Built-in surge protection power supply, reverse connection protection circuit
Red LED status indicator for easy identification of operation status
- ※ IP65 level of protection



Selection Guide

LS	12	—	S	15	N	1
①	②		③	④	⑤	⑥
① Model: LS: Laser Sensor						
② DIA. of sensing side: Number: DIA. of sensing side (unit:mm)						
③ Sensing type: S: Diffuse reflective type、R: Retroreflective type、D: Through-beam type						
④ Sensing distance: Number: Sensing distance (unit:cm)						
⑤ Control output: N: NPN、P: PNP						
⑥ Operation mode: 1: Light ON、2: Dark ON						

Specifications

Specifications				
Model	NPN.NO	LS12-S15N1	LS12-R6MN1	LS12-D25MN1
	NPN.NC	LS12-S15N2	LS12-R6MN2	LS12-D25MN2
	PNP.NO	LS12-S15P1	LS12-R6MP1	LS12-D25MP1
	PNP.NC	LS12-S15P2	LS12-R6MP2	LS12-D25MP2
Detection type	Diffuse reflection	Retro-reflective	Through-beam	
Sensing distance	0-15CM	0-6M	0-25M	
Setting distance(Sa)	0-1MM	0-1MM	0-1MM	
Adjustment method	Tail potentiometer			
Spot and beam	beam invisible Spot visible size: 2/1/0.5mm			
Hysteresis	≤10%			
Light pointing angle	3°			
Standard target	white card reficetion rate 90%			
Detection target	Opaque Objects and Transparent Objects			
Supply voltage	DC:10-30VDC			
Leakage current	≤0.6mA			
Response frequency(F)	600Hz(DC)			
Ambient illuminance incandescent	incandescent lights3000Lux sunshines≤100Lu			
Consumption current	Diffuse reflection and Retro-reflective<15mA Through-beam<25mA			
Load current	200mA			
Voltage drop	DC≤1V			
Circuit protection	short-circuit.EMIprotection reverse polarity protection			
Output indicator	Red LED			
Ambient temperature	-20~+55°C			
Shock	500m/s(50G) in each X,Y,Z direction for 3times			
Vibration	1mm amplitude at frequency 10~55Hz(for 1min) in each X,Y Z direction for 2hours			
Protection degree	IP65			
Connection	2mPVC cable or connector			
Material	Nickel-copper alloy			
Sensing side	PC			

Dimension

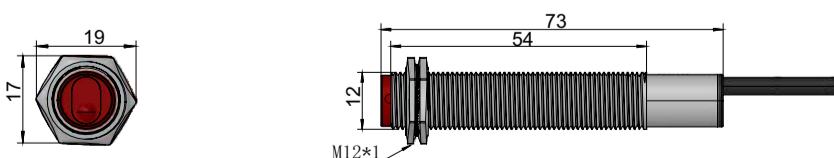



Wenzhou Gtric Technology Co., Ltd.

Wenzhou Gtric Technology Co., Ltd.
TEL:0577-62734566
Web:<http://www.gtric.com>
Mail:yaohaofeng@gtric.com