

# SENSOR PRODUCTS SELECTION MANUAL



Wenzhou Gtric Technology Co., Ltd.  
TEL:0577-62734566  
Web:<http://www.gtric.com>  
Mail: [yaohaofeng@gtric.com](mailto:yaohaofeng@gtric.com)

# Company introduction

Wenzhou Gtric Technology Co., Ltd. is located in Yueqing IoT sensors Park, which covers 5,000 square meters, with over 100 employees. We are focuses on intelligent manufacturing and industrial automation, our main businesses are sensors, encoders, button switch, coupling, expansion set and other industrial automation products, providing standard and individual products and solutions for customers.

Our products cover over 20 series, 1000specificatison, which have passed CCC, CE, UL, ISO9001 certification as well as EU RoHS Environmental Directives.

Based on our technical advantages, Gtric can provide industrial automation solution according to customers' requirements.

**We support OEM & ODM, if you need  
please feel free to contact us**



Installation conditions

Non shielded proximity switches can achieve maximum operating distance (with the diameter of the relevant); but in order to prevent the switch around the metal impact on the switch, the sensor head must be in a certain gap with the surrounding metal (Figure 1).

Due to the special shielding effect inside the shield, the radial magnetic field of the side is reduced, and the induction distance is about 60% of the non shield type, because it can be flush mounted in the metal (Figure 2).

The magnetic sensor is not affected by the conditions of installation, as long as the material around the material is not magnetized.

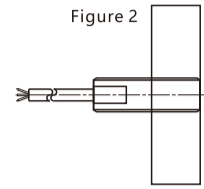
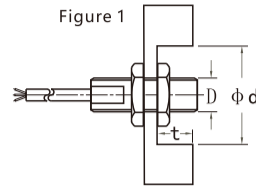

In order to prevent mutual interference, we must keep the minimum distance between each other (Figure 3).

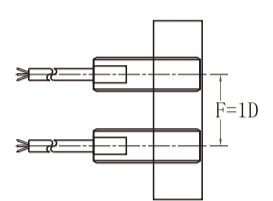
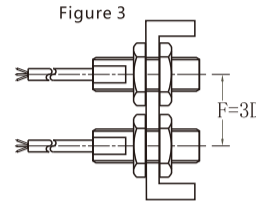

Please refer to the specific data of various types of instructions.

Output mode and electrical characteristics

DC 2-wire system NO or NC

The load must be connected in series in the sensor to work, there is a polarity and short circuit protection function; in the open circuit state, there is a very small leakage current; in the closed circuit, the switching element has a smaller voltage drop.

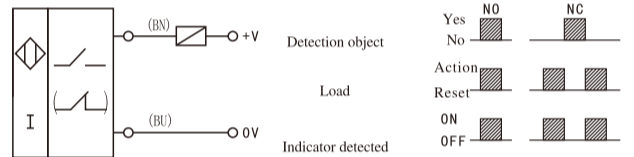

DC 3-wire system (N,P type) NO or NC

These switches are connected to the load and power supply separately; the polarity, short circuit and overload protection function, and the residual current can be ignored.

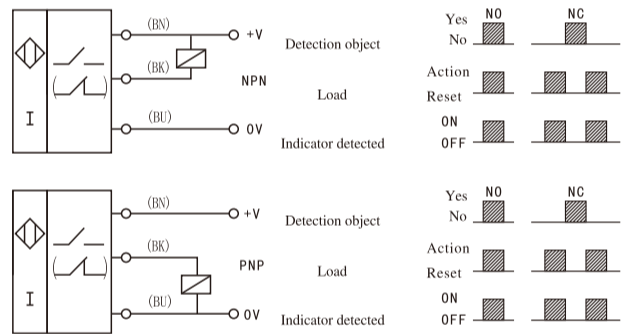

AC 2-wire system NO or NC

The load must be connected in series in the sensor, in the closed circuit, the switching element has a smaller voltage drop.

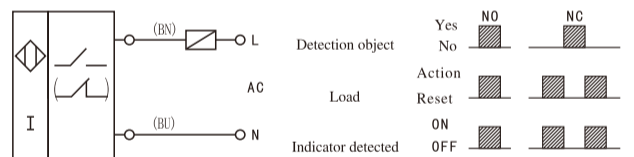

DC 4-wire system (NPN, PNP Type) NO+NC

Sensor switches can provide 2 groups of output NO+NC

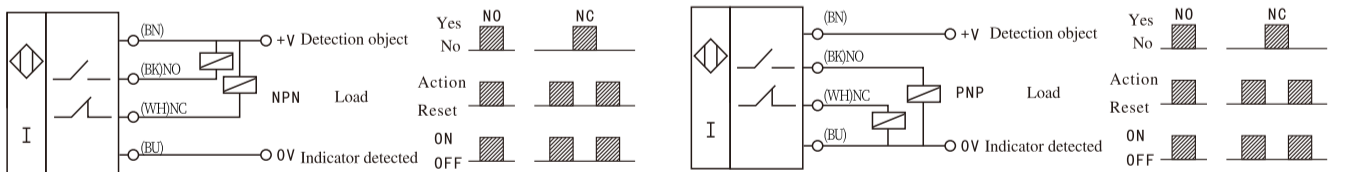

DC 4-wire system (NPN, PNP Type) NO/NC

The switches can provide two groups of output NO or NC

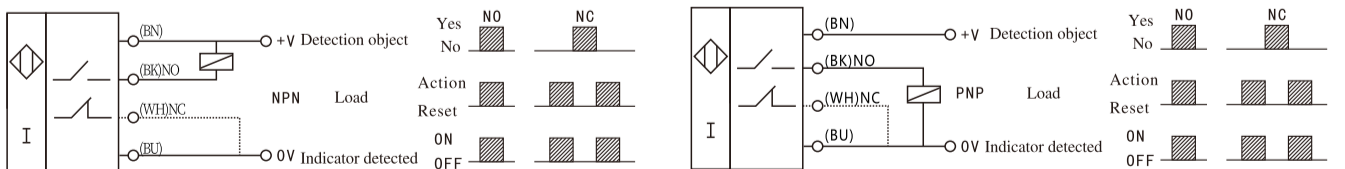

NO+NC Ac/Dc five wire (relay output) NO + NC

These switches can provide to often open, closed two group relay output.

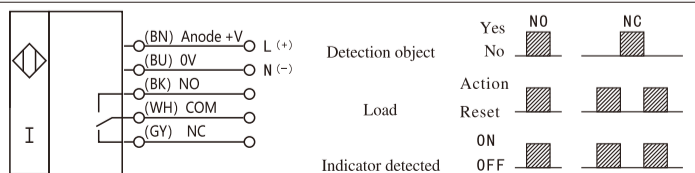

❖ Series and parallel connection of proximity switch

OR connection (NPN and PNP types can be used mixed) series When the proximity switch is OR connected, the action of any proximity switch can drive load. The quantity of the proximity switches depends on the sum of leakage current. More connections are available given that it doesn't affect the loading action.

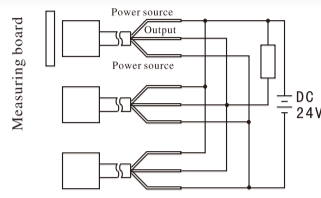

OR connection of NPN output

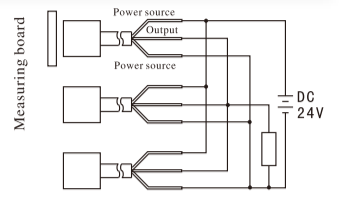

OR connection of PNP output

❖ AND connection (series)

When the proximity switch is AND connected, the action of all proximity switches can drive load. The quantity of the proximity switches depends on the sum of saturation voltage. More connections are available given that it doesn't affect the supply voltage of the proximity switch. The response frequency of the proximity switch is the accumulation of initialized reset of various proximity switch.

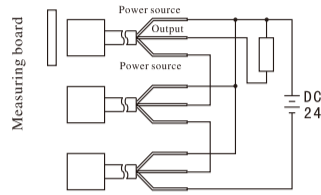

NPN connection of AND output

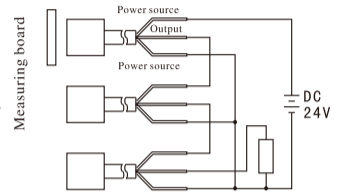

PNP connection of AND output

❖ Series and parallel connection of proximity switch

AND connection (series) NPN, PNP mixed-use

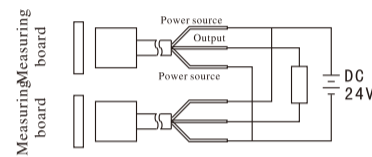

Promixity switches matters need attention

❖ Cautions when connected or disconnected with the power supply

When connecting the proximity switch with the counter and the programmable controller, there isn't any problem because of the built-in initialized reset circuit. Please avoid the conditions mentioned below.

The detection object lies around the detection distance of the proximity switch; For DC voltage type and DC switch type, when power supply is turned on (turned off), time constant rises (drops) greatly; There is self-excitation and noise when the AC switch type proximity switch is power-on (off).

❖ Capacitor, light load

The proximity switch can't have the capacitor or light that has larger jumping current as the load directly connected to be connected through a relay or series connected with a current-limiting resistance. The peak current set by current-limiting resistance R is within the load current of the proximity switch; Make sure to connect through load.

$$\frac{\text{Supply voltage } V}{\text{Peak load current value of proximity switch } mA} \leq R(K\Omega)$$

$$\text{Allowable loss of resistance } R (W) = \frac{\text{Supply voltage } V^2}{R(K\Omega)} \times 2 \text{ times above}$$

❖ Installation notice of proximity switch

Don't use it in the open air, and use a protective cover, if necessary.

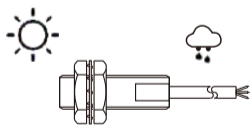

Don't knock the detection surface with hard objects and use a protective cover, if necessary.

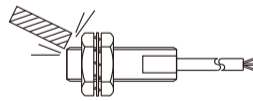

Don't use it in the environment with corrosive objects.

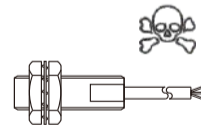

Don't fasten it with a big force, but fasten it with spring washer.

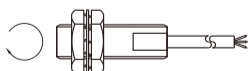

The proximity switch must be equipped individually with metal flexible pipe, and don't make it with the electric line and power line in the same metal flexible pipe.

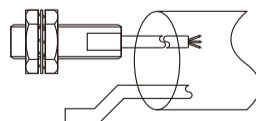

Don't stretch the power line of the proximity switch with a big force.

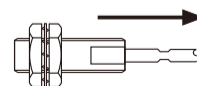

- ※ Easy installation IP65 rated protection  
Three years warranty
- ※ Multiple specifications are available
- ※ Can be customized



## Selection Guide

LC	20	-	04	NP	2
①	②		③	④	⑤
① <b>Model:</b> LC:light curtain sensor					
② <b>Beam Spacing Number:</b> 20mm Beam Spacing (unit: mm)					
③ <b>Number of spots Number:</b> Number of spots (unit: mm)					
④ <b>Power supply:</b> NP:NPNorPNP、 J:Relay output					
⑤ <b>Control output:</b> 1:Normally open、 2:Normally closed					

## Specifications

Light curtain optical axis spacing 20mm series			
Protection height	60-2000mm(regular)	Workingtemperature	1-10-55°
Optical axis spacing	20mm/40mm	Working environment humidity	<85%
Number of optical axes	4,6,8,10....	Output current	≤200mA
Operating Voltage	DC24V+20%	power	<5W
Insulation resistance	≥100MΩ	Resist light interference	10000Lux
Responsetime	<10ms	Dielectric strength	ACI500V.60SNo breakdown or flicker
Protective distance	0.1-2500mm (Can Customizable)	cross-sectional size	30*30mm
output method	Npn or Pnp (regular)/relay NO/relay NC (optional)		

## Dimension

### 20mm Transistor Output

Light curtain optical axis spacing 20mm series			
Model	Number of beams	Protection height(mm)	Shell height(mm)
LC20-04-NP2	4	60	110
LC20-06-NP2	6	100	160
LC20-08-NP2	8	140	200
LC20-10-NP2	10	180	240
LC20-12-NP2	12	220	280
LC20-14-NP2	14	260	320
LC20-16-NP2	16	300	360
LC20-18-NP2	18	340	400
LC20-20-NP2	20	380	440
LC20-22-NP2	22	420	480
LC20-24-NP2	24	460	520
LC20-26-NP2	26	500	560
LC20-28-NP2	28	540	600
LC20-30-NP2	30	580	640
LC20-32-NP2	32	620	680
LC20-34-NP2	34	099	720
LC20-36-NP2	36	700	760

Light curtain optical axis spacing 20mm series			
Model	Number of beams	Protection height(mm)	Shell height(mm)
LC20-38-NP2	38	740	800
LC20-40-NP2	40	780	840
LC20-42-NP2	42	820	880
LC20-44-NP2	44	860	920
LC20-44-NP2	46	900	960
LC20-48-NP2	48	940	1000
LC20-50-NP2	50	980	1040

## 20mm Intermediate relay Output

Light curtain optical axis spacing 20mm series			
Model	Number of beams	Protection height(mm)	Shell height(mm)
LC20-04-J	4	60	120
LC20-06-J	6	100	170
LC20-08-J	8	140	210
LC20-10-J	10	180	250
LC20-12-J	12	220	290
LC20-14-J	14	260	330
LC20-16-J	16	300	370
LC20-18-J	18	340	410
LC20-20-J	20	380	450
LC20-22-J	22	420	490
LC20-24-J	24	460	530
LC20-26-J	26	500	570
LC20-28-J	28	540	610
LC20-30-J	30	580	650
LC20-32-J	32	620	690
LC20-34-J	34	660	730
LC20-36-J	36	700	770

Dimension

GTRIC®

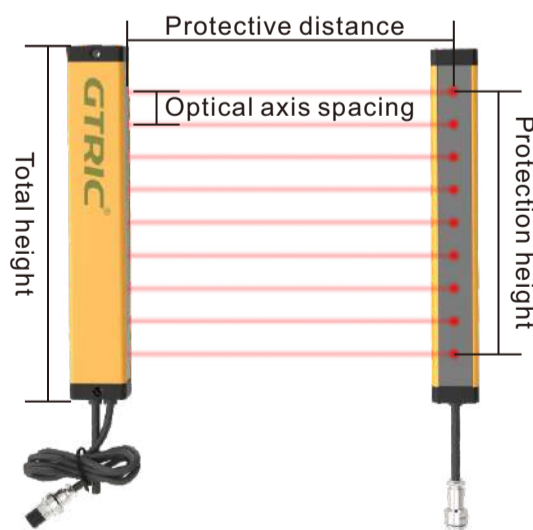

## 40mm Transistor Output

Light curtain optical axis spacing 40mm series			
Model	Number of beams	Protection height(mm)	Shell height(mm)
LC40-04-NP2	4	120	200
LC40-06-NP2	6	200	270
LC40-08-NP2	8	280	350
LC40-10-NP2	10	360	430
LC40-12-NP2	12	440	510
LC40-14-NP2	14	520	590
LC40-16-NP2	16	600	670
LC40-18-NP2	18	680	750
LC40-20-NP2	20	760	830
LC40-22-NP2	22	840	910
LC40-24-NP2	24	920	990
LC40-26-NP2	26	1000	1070
LC40-28-NP2	28	1080	1150
LC40-30-NP2	30	1160	1230
LC40-32-NP2	32	1240	1310
LC40-34-NP2	34	1320	1390
LC40-36-NP2	36	1400	1470
LC40-38-NP2	38	1480	1550
LC40-40-NP2	40	1560	1630
LC40-42-NP2	42	1640	1710
LC40-44-NP2	44	1720	1790



20mm pitch light curtain sensor use effect



40mm pitch light curtain sensor use effect

## 40mm Intermediate relay Output

Light curtain optical axis spacing 40mm series			
Model	Number of beams	Protection height(mm)	Shell height(mm)
LC40-04-J	4	120	210
LC40-06-J	6	200	280
LC40-08-J	8	280	360
LC40-10-J	10	360	440
LC40-12-J	12	440	520
LC40-14-J	14	520	600
LC40-16-J	16	600	680
LC40-18-J	18	680	760
LC40-20-J	20	760	840
LC40-22-J	22	840	920
LC40-24-J	24	920	1000
LC40-26-J	26	1000	1080
LC40-28-J	28	1080	1160
LC40-30-J	30	1160	1240

Light curtain optical axis spacing 40mm series			
Model	Number of beams	Protection height(mm)	Shell height(mm)
LC40-32-J	32	1240	1320
LC40-34-J	34	1320	1400
LC40-36-J	36	1400	1480
LC40-38-J	38	1480	1560
LC40-40-J	40	1560	1640
LC40-42-J	42	1640	1720
LC40-44-J	44	1720	1800



NPN/PNP Output

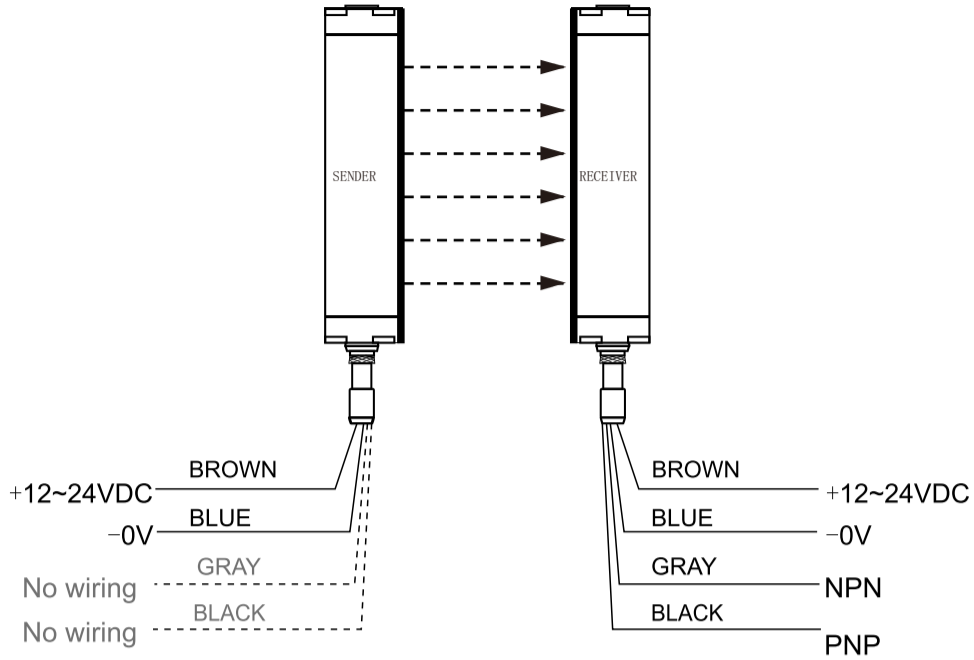

Transmitting end

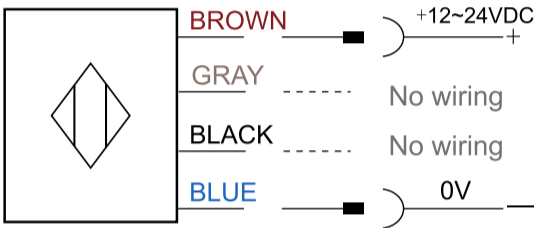

Receiving end

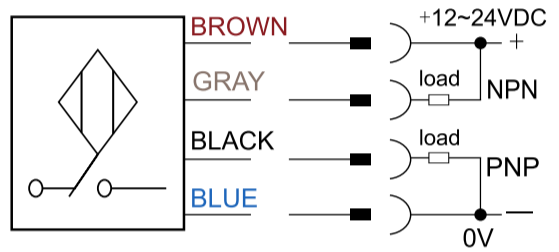

The output signal of this product is transistor output  
 NPN NC/NPN NO/PNP NO/PNP NC Four outputs can only choose one of the two  
 Default NPN NC or PNP NC

Common Relay Output

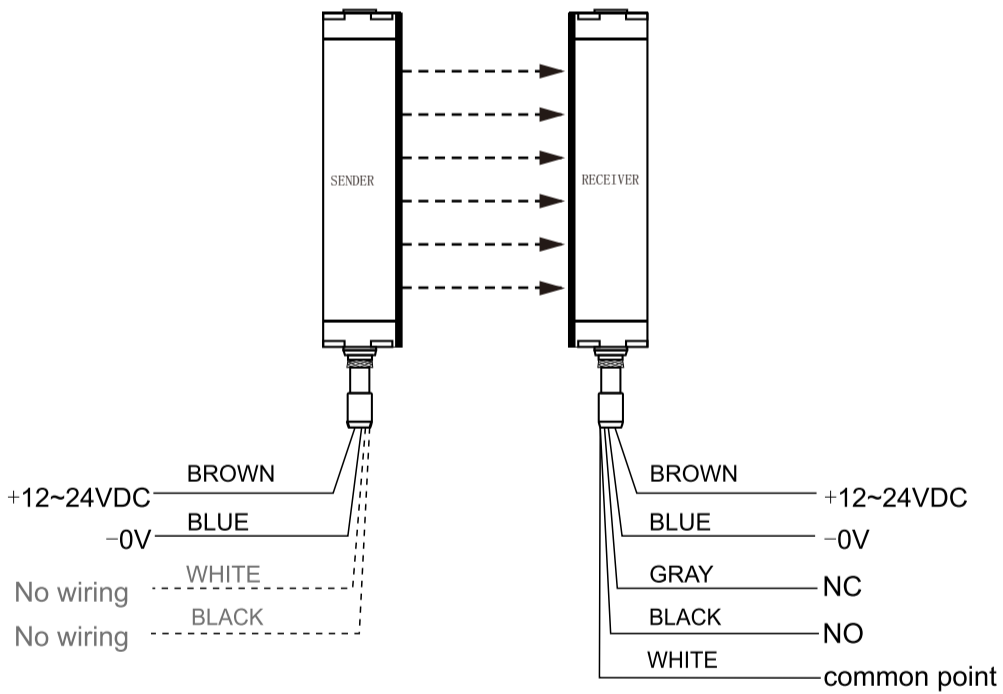

Transmitting end

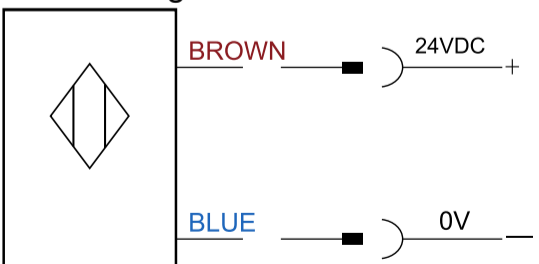

Receiving end

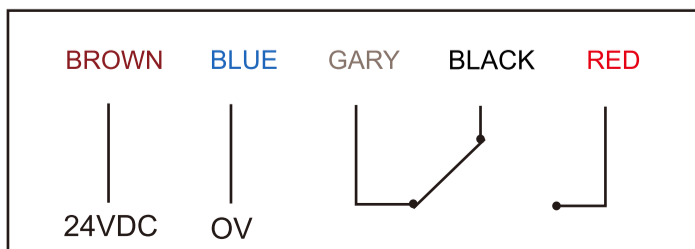
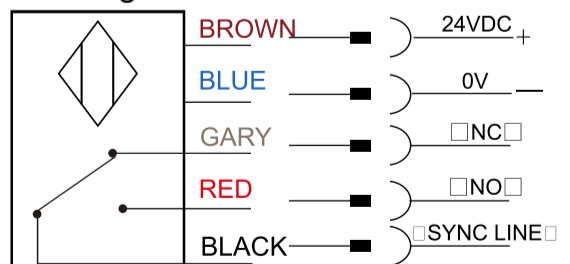



**GTRIC<sup>®</sup>**

Wenzhou Gtric Technology Co., Ltd.

Wenzhou Gtric Technology Co., Ltd.  
TEL:0577-62734566  
Web:<http://www.gtric.com>  
Mail:[yaohaofeng@gtric.com](mailto:yaohaofeng@gtric.com)